

**52
WEEKS
OF
CREE**

**BY
JULIA OUELLETTE
REPEAT AFTER ME**

Thank you for purchasing our 52 weeks of Cree book. The words we are sharing are from our area and we realize some areas may say the words slightly different.

The best use of this book is to take each lesson and learn it thoroughly before moving on to the next lesson.

We hope to one day have a fluent conversation with you in the Cree language.

Hai Hai

Julia Ouellette



WWW.REPEATAFTERMECREE.COM

Scan Here For Video #1: Repeat After Me



Pronounce The Words With The Video Above







	Mit - doon - Ahp - Soon
	Gis-See-Bee-Gin-Ghi-Cha-Gun
	Us-Soos-Ga-ma-Doo-Win
	Gah - See - Chee - Chee
	Ahk - Soo - Win

Practice these words for a
week or two before moving
on to the next lesson :)

Scan Here For Video #2: Repeat After Me

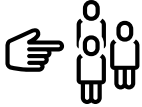

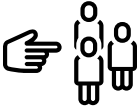

Pronounce The Words With The Video Above

	Bee - Wahb - Bah - Min
	Bee - Wah - Bim
	Doe - Wah - Bim
	Be-Wah-Bim-Nahn
	Doe-Wah-Bim
	Be-Ah-Wah-hin Soon-Knee-Ass
	Doe-Nah-Skween

Scan Here For Video #2: Repeat After Me



Pronounce The Words With The Video Above

	Bee-We-Chee-Win
	Wee-Ghee-yew
	Be-we-ghee-yew

Practice these words for 1-
2 weeks before moving
onto the next lesson

Scan Here For Video #3: Repeat After Me



Pronounce The Words With The Video Above

	Nah-Mwee-Ghee-Skwah
WHAT ELSE	Gee-Gwhy-Me-Nah
LET'S GO! 	ooo-dee-nah doot-dee-dahn
LET'S GO! Visit	Doe-Guew-Gee-Dahn
<i>Come!</i> 	Bee-We-Chee-Win
	Ghis-tew-Ah-We-Deh-Meh
MY 	Nit-Dah-Wah-Sim-Suk

Scan Here For Video #3: Repeat After Me



Pronounce The Words With The Video Above

	Nooo-Sim-Muk
	Soon-Knee-Ass
	Owe-Weh-Hin Soon-Knee-Ass
	Dant-Deh-Doot-Deen

Practice these words for 1-
2 weeks before moving
onto the next lesson

Scan Here For Video #4: Repeat After Me









Pronounce The Words With The Video Above

	Guy - Yah
	Guyk - Stoo - Dah
	Bin - Nah - Wah - Soo
	Gee-Dah-Skiss-Sah-Knee
	Bush-Stah-Skiss-Sah-Knee
	Bush - Gah
	Gee - Chug - Gah - Nah

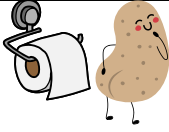
Scan Here For Video #4: Repeat After Me



Pronounce The Words With The Video Above

	Gim - Sah - ho
	Wah - Buck - Sees
	Gees - Skwah
	Bee - Ho
	Boo - Stush - Saw - Gee
	Gee - Dus - Saw - Gee
	Me - Me - Doh

Scan Here For Video #5: Repeat After Me





Pronounce The Words With The Video Above

	Ah - Bee- Gwah - ha
	ooo - Dee- Nah
	Gip - Bah - Ha
I'm 	Nih - Dahk - Go - Sin
	Nim - Mew - Mah - Cha - Hoon
	Bah - Mee- Cha - Gee
	See - Gee- Bay - Ace

Scan Here For Video #5: Repeat After Me



Pronounce The Words With The Video Above

	Iss - Sgwah - Deem
	Ah-Bee-Gwah-Ha Iss-Sgwah-Deem
	Ooo-Dee-Nah Iss-Sgwah-Deem

Practice these words for 1-
2 weeks before moving
onto the next lesson

Scan Here For Video #6:
Repeat After Me





Pronounce The Words With The Video Above

	Eee-Wah-See-Gass-Sah-Mo
	Eee-Bee-Ah-Hoos-Sah-Mo
	Eem -Sah-Ah-Doos-Sah-mo
	Eee-Bwat-Sah-Mo
	Eee-my-Dye-doh
	Eee-bee-daw-dah-meh
	Eee-Mah-Dook-Sew-Ga-Mihk

Scan Here For Video #6: Repeat After Me



Pronounce The Words With The Video Above

	Ooos-Bwah-Gun
	Iss-Stee-Mow
	Imm-Bah-Gwee-Sah-Goos-Ga- Mihk
	Eee-Bee-Ghee

Practice these words for 1-
2 weeks before moving
onto the next lesson

Scan Here For Video #7: Repeat After Me







Pronounce The Words With The Video Above

	Nih-Cha-Bahn
	Nuu - Gom
	Ni-Mush-Shoom
	Nuu-Dah-We
	Nig - Gah - We
	Nih - Steeze
	Nih - Miss

Scan Here For Video #7: Repeat After Me



Pronounce The Words With The Video Above

	Nis - See - Miss
	Ghee-Skwah
	Bee-hoh
	Gah-Gee-Doh Wee-Yah-Won- gee

Practice these words for 1-
2 weeks before moving
onto the next lesson

Scan Here For Video #8:
Repeat After Me





Pronounce The Words With The Video Above

	Sah-Gway-Gun
	Gwah-Bay-Gun
	Geez-Jayz-Ghee-Bog-Gah-Niss
	Moo-Gohm-Mah-Niss
	Miss-Dee-Goo-Mahn
	Eeee-me-gwah-niss
	Eee-me-gwahn

Scan Here For Video #8:
Repeat After Me



Pronounce The Words With The Video Above







	Be-Doon-Gun
	G'weese-G'wee-Bay-Gun
	It-D'wee-Bay-Gun

Practice these words for 1-
2 weeks before moving
onto the next lesson

Scan Here For Video #9:
Repeat After Me

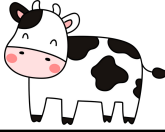

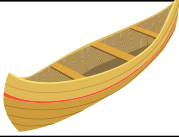

Pronounce The Words With The Video Above

	Moose-Swah
	Ah-Dim
	Dee-Dub-Buh-Win
	Moose-Stoos
	Nahp-Be-Sis
	Chi-Mahn
	Iss-Gwee-Siss

Scan Here For Video #9:
Repeat After Me







Pronounce The Words With The Video Above

	Eee-Mee-Gwah-Niss
	Bih-Mih-Ha-Gun
	Nih-Chee-Wah-Gun
	Kih-Chee-Wah-Gun
	Is-Gwew
	Nah-Bew
	Moo-Gah-Mahn

Scan Here For Video #9:
Repeat After Me



Pronounce The Words With The Video Above

	Min-Noose
	Meat-Soon-Nah-Dik
	Oooo-Seh
	Us-Seh-Knee
	Muss-Snay-Gun
	Buss-Gwah-Mah-Doon

Practice these words for 1-
2 weeks before moving
onto the next lesson

Scan Here For Video #10:
Repeat After Me



Pronounce The Words With The Video Above

	Mew-Skah-Min
	Knee-Bin
	Duck-Gwah-Ginn
	Buh-boon
	Aye-Mew-Geese-Sah-Gow
	Be-Yak-Geese-Sah-Gow
	Knew-Sue-Geese-Sah-Gow

Scan Here For Video #10:
Repeat After Me



Pronounce The Words With The Video Above

	Nih-Stoh-Geese-Sah-Gow
THURSDAY	New-Geese-Sah-Gow
FRIDAY	New-Ah-No-Geese-Sah-Gow
SATURDAY	Nih-Goot-dah-wah-sook Geese-sah-gow

Practice these words for 1-
2 weeks before moving
onto the next lesson

Scan Here For Video #11:
Repeat After Me



Pronounce The Words With The Video Above

	Me - Gwow
	Ous-Sow-Me-Gwow
	Ous-Sah-Wow
	Ous-Guss-Gah-Soon-Nah-Gwun
	See-Bee-Gwow
	Neep-Bye-My-Yah-Dun
	Wah-Buh-Gah-New-Nah-Gwun

Scan Here For Video #11:
Repeat After Me



Pronounce The Words With The Video Above

	Gus-Gah-Dew-Sah-Wow
	Gus-Git-Dee-Wow
	Wahp-Bis-Gow
	Wass-Good-Deen-Gun

Practice these words for 1-
2 weeks before moving
onto the next lesson

Scan Here For Video #12:
Repeat After Me



Pronounce The Words With The Video Above

	Bis-Skom-Nah
	See-Wee-Dah-Gun
	See-Ween-Gun
	Wee-Yass
	Doo-Doo-Sah-Bwee
	Nih-Bee
	Ah-Goo-Dee-Cha-Gun

Scan Here For Video #12:
Repeat After Me



Pronounce The Words With The Video Above

	Wah-Gass
	Wah-We-Yah-Gah-Niss
	Wah-We-Yah-Gun
	Bah-Gweese-Sah-Gun
	Bah-Bah-Gwun
	Nah-Buh-Dwah-Gah
	Eee-Mee-Gwah-Niss

Scan Here For Video #12:
Repeat After Me



Pronounce The Words With The Video Above









Gih-Dah-Nah-Biss

Practice these words for 1-
2 weeks before moving
onto the next lesson

Scan Here For Video #13:
Repeat After Me



Pronounce The Words With The Video Above

	Gee-Gee-Bah-Gun
	Moo-Gah-Mahn
	Wah-Wah
	Me-Chim-Ah-Bwee
	Knee-Dee
	Wee-Chee-Guss-Go-See
	Nih-bee

Scan Here For Video #13:
Repeat After Me



Pronounce The Words With The Video Above

	Ous-Sah-Wahss
	Bah-Gah-Cha-Gun
	We-Yah-Gah-Niss
	We-Yah-Gun
	Bicha-Gwass
	See-Wah-Bweese
	Nah - Bween

Practice these words for 1-
2 weeks before moving
onto the next lesson

Scan Here For Video #14: **Repeat After Me**



Pronounce The Words With The Video Above

	Ah-Nooch
	Wah-Bah-Geh
	Oooo-Dahk-See
This Morning	Geek-Seep
Last Night	Dihp-Skoh
This Evening	Ooo-Dahk-Seh-Geh
Day Before Yesterday	Wass-Dahk-See

Scan Here For Video #14:
Repeat After Me



Pronounce The Words With The Video Above

Not Last Night But The Night Before	Wass-Dip-Skoh
	Eye-Yah-Beh

Practice these words for 1-
2 weeks before moving
onto the next lesson

Scan Here For Video #15:
Repeat After Me



Pronounce The Words With The Video Above

What is your name?	Dan-See See-Gass-Sah-Ween
My Name Is...	Nit-See-Gass-Suun
Where are you from?	Dant-Dee-Ooh-Chig-Gee-Yah
I'm From	Ooh-Ghin-Knee-Yah

Practice these words for 1-
2 weeks before moving
onto the next lesson

Scan Here For Video #16:
Repeat After Me



Pronounce The Words With The Video Above

Come with me	Be-Wee-Chee-Win
Come with us	Be-Wee-Ghew-Nahn
Can I got with you	Gah-Gee-Wah-Ghew-Ah-Din-Chi
Can I Go With You Guys?	Gah-Gee-We-Ghew-Ah-Din-Nah-Wow-Chi
Go Home	Ah-Dig-Gee-Wee
Stay Home	Eye-Yah-Bih
They Went Home	Ah-Dih-Gee-Wee-Wuk
He/She Went Home	Ah-Dih-Gee-Weeyew

Practice these words for 1-2 weeks before moving onto the next lesson

Scan Here For Video #16:
Repeat After Me



Pronounce The Words With The Video Above

He/She Went Home	Ah-Dih-Gee-Weeyew
My Name Is...	Nit-See-Gass-Suun
Where are you from?	Dant-Dee-Ooh-Chig-Gee-Yah
I'm From	Oooh-Ghin-Knee-Yah

Practice these words for 1-
2 weeks before moving
onto the next lesson

Scan Here For Video #17:

Repeat After Me



Pronounce The Words With The Video Above

	Doo-Doo-Sahp-Bwe
	Iss-Gwee-Sahp-Bwee
	Soon-Nah-Bwee
	Nih-Bee
	Iss-Gah-Dee-Wah-Bwee
	Bee-Gah-Dee-Wah-Bwee
	Knee-Dee
	Gahm-Knee-Gwee-Seh
	Ooo-Chee-Bwee-Gees









Practice these words for 1-2 weeks before moving onto the next lesson

Scan Here For Video #18:



Repeat After Me

Pronounce The Words With The Video Above

	Ah-Dim
	Ah-Dim-Mok
	Min-Noose
	Min-Noose-Suk
	Ahp-Sim-Moose-Sous
	Ahp-Sim-Moose-Sous-Suk
	Moose-Swah
	Moose-Swuk
	Miss-Ah-Dim

Scan Here For Video #18:

Repeat After Me



Pronounce The Words With The Video Above

	Miss-Ah-Dim-Muk
	Mous-Stooos
	Mous-Stooos-Suk
	Sah-Gahk
	Sah-Gahk-Gwuk
	See-seep
	See-seep-Buk
	Nis-Gah
	Nis-Guk

Practice these words for 1-2 weeks before moving onto the next lesson

Scan Here For Video #18:



Repeat After Me

Pronounce The Words With The Video Above

	Goo-Goose
	Goo-Goose-Suk
	Dug-Gwah-Now
	Dug-Gwah-Now-Wuk
	Wah-Gah-Yous
	Wah-Gah-Yous-Suk
	Ghin-Knee-Bik
	Ghin-Knee-Bah-Gwuk
	Bee-Sees

Practice these words for 1-2 weeks before moving onto the next lesson

Scan Here For Video #18:

Repeat After Me



Pronounce The Words With The Video Above

	Bee-Sees-Suk
	Ung-Gwah-Ghask
	Ung-Gwah-Ghask-Suk
	Ah-Hah-Soo
	Ah-Hah-Soo-Wuk
	Gah-Gah-Goo
	Gah-Gah-Goo-Wuk
	Ah-Misk
	Ah-Misk-Gwuk

Practice these words for 1-2 weeks before moving onto the next lesson

Scan Here For Video #18:



Repeat After Me

Pronounce The Words With The Video Above

	Wah-Ghusk
	Wah-Ghusk-Swuk
	Mees-Skah-Nahk
	Aye-Giss
	Egg-Suk
	Oooh-Whoo
	Oooh-Whoo-Wuk

Practice these words for 1-2
weeks before moving onto
the next lesson

Scan Here For Video #19:



Repeat After Me

Pronounce The Words With The Video Above

	Gan-Nah-Wee-Chig-Eee-Wuk
	Doot-Deet-Dan
	Ahk-Sue-Gah-Mik
Let's go to the hospital	Doot-Deet-Dan Ahk-Sue-Gahm-Goo
Band Office	Ah-Skew-Gah-Mik
Let's go to the Band Office	Doot-Deet-Dan Ahk-Skew-Gum-Goo
	Sous-Gwat-Day-Gwew-Gah-Mik
Let's go the the arena	Doot-Deet-Dan Sous-Gwat-Day-Gum-Goo
	Meat-Sou-Gah-Mik

Practice these words for 1-2 weeks before moving onto the next lesson

Scan Here For Video #19:



Repeat After Me

Pronounce The Words With The Video Above

Let's go the the Restaurant	Doot-Deet-Dan Meat-Sou-Gum-Goo
	Sih-Mah-Gun-Sou-Gah-Mik
Let's go the the Police Station	Doot-Deet-Dan Sih-Mah-Gun-Sou-Gum-Goo
	Musk-Gee-Gew-Gah-Mik
Let's go to the dr. Office	Doot-Deet-Dan Musk-Gee-Gew-Gum-Goo
	Ah-Dah-Wew-Gah-Mik
Let's go to the Store	Doot-Deet-Dan Ah-Dah-Wew-Gum-Goo

Practice these words for 1-2 weeks before moving onto the next lesson

Scan Here For Video #20

Repeat After Me



Pronounce The Words With The Video Above







	Nah-Mah-Ghee
Left Side	Nah-Mah-Ghee-Iss-Seh
	Gee-Ghin-Ski
On the right side	Gee-Ghin-Ski-Iss-Seh

Practice these words for 1-2 weeks before moving onto the next lesson

Scan Here For Video #21: Repeat After Me



Pronounce The Words With The Video Above

	Nih-Mush-Shoom
	Nuu-Goom
	Nih-Ma-ma
	Nih-Gah-Wee
	Nih-dah-dah
	Nuu-Dah-Wee
	Niss-Deese



Practice these words for 1-2
weeks before moving onto the
next lesson

Scan Here For Video #21:



Repeat After Me

Pronounce The Words With The Video Above

	Nim-Miss
	Niss-See-Miss

Practice these words for 1-2 weeks before moving onto the next lesson

Scan Here For Video #22:



Repeat After Me

Pronounce The Words With The Video Above

Understand	Nihn-Stoo-Dah
I Understand	Nihn-Stoo-Dean
We Understand	Nihn-Stoo-Dean-Nahn
He/She Understands	Nihn-Stoo-Dum
Do You Understand?	Ghin-Stoon-Dean
Does Everyone Understand?	Ghin-Stoo-Dean-Now-Wow

Practice these words for 1-2 weeks before moving onto the next lesson

Scan Here For Video #23:



Repeat After Me

Pronounce The Words With The Video Above

	Soon-Knee-Yass
	Soon-Yow-Gah-Mik
 BORROW	Gahg-Gee-Daht-Dah-Mon
Can I borrow From You?	Gahg-Geen-Gah-Dahm-Din
Lend me...	Owe-Wah-Hin
	Mid-Dah-Bee-How-Wahp-Skous
	Nee-Yahn-Bee-Wahp-Skous

Practice these words for 1-2
weeks before moving onto the
next lesson

Scan Here For Video #23:



Repeat After Me

Pronounce The Words With The Video Above

	Mid-Daht-Doe-Wah-Bissk
	Niss-Doe-No-Daht-Doe-Wah-Bissk
	Nee-Yah-Now-Bissk
	Be-Yahk-Wah-Bissk
	Knee-Saw-Bissk
	Be-Yahk-Soon-Knee-Yass
Lend me (Money)	Owe-Wah-Hin + (Money)

Practice these words for 1-2 weeks before moving onto the next lesson

Scan Here For Video #24:



Repeat After Me

Pronounce The Words With The Video Above

He/She Remembers	Giss-Gah-Suu
Do You Remember?	Giss-Gah-Sin
Does Anyone Else Remember?	Owe-We-Yahk Gee-Gah-Dahk Giss-Gah-Suu
Do You Guys Remember?	Giss-Gah-Sin-Nah-Wow





Practice these words for 1-2
weeks before moving onto the
next lesson

Scan Here For Video #25:



Repeat After Me

Pronounce The Words With The Video Above

	Sah-Gay-Gun
	Bawk-Goo-Bee
	Bah-Gaw-Seh-Mo
	Goo-Gee

Practice these words for 1-2 weeks before moving onto the next lesson

Scan Here For Video #26:



Repeat After Me

Pronounce The Words With The Video Above

	Knee-Bin
	Bee-Sim
	Bah-Gah-Seh-Mo
Let's Go Swimming	Doh-Bah-Gah-Seh-Mo-Dan
It's Hot Outside	Giss-Dew-Ah-Wee-Dah-Mehk
It's Hot Outside	Giss-Sass-Dew
	Nih-Dup-We-Sin

Practice these words for 1-2 weeks before moving onto the next lesson

Scan Here For Video #26:



Repeat After Me

Pronounce The Words With The Video Above

Go Swimming	Doh-Bah-Gah-Seh-Mo
	Goo-Gee
	Sah-Gay-Gun

Practice these words for 1-2 weeks before moving onto the next lesson

Scan Here For Video #27:



Repeat After Me

Pronounce The Words With The Video Above

Go Play	Doh-Mee-Dah-Wee
Go Play Outside	Doh-Mee-Dah-Wee Ah-Wee-Dah-Meh
Come Here	Ah-Stum
Come Over Here	Ah-Stum Oooo-Deee
Get Away	Ah-Wuss
Get Away From Here	Ah-Wuss Ooo-Dah
Get Away From Over There	Ah-Wuss Eeee-Go-Dah

Practice these words for 1-2 weeks before moving onto the next lesson

Scan Here For Video #27:



Repeat After Me

Pronounce The Words With The Video Above

Wash It	See-Bee-Gah-Nah
Dry It	Back-Gwah-Ha

Practice these words for 1-2 weeks before moving onto the next lesson

Scan Here For Video #28:



Repeat After Me

Pronounce The Words With The Video Above

	Nih-Doo-Dah
	Sqaw-Da-Beh
Quit Fighting	Boo-Nah-New-Ding-Gee
	Gin-Nah-Chee-Dah
Get Away From Over There	Ah-Wuss Eeee-Go-Dah
	Bim-Moh-Dee Guy-Bim-Bah-Dah
Get Down	Knee-Douk-See

Practice these words for 1-2 weeks before moving onto the next lesson

Scan Here For Video #28:



Repeat After Me

Pronounce The Words With The Video Above

A woman with dark hair is looking over a white sign that says "Be careful!". There are three small red hearts above the sign.	Bee-Yah-Dik
A simple icon of a person with a yellow head and blue body sitting on an orange chair.	Ah-Beh
Don't Do That	Gikes-Doo-Dah
A small chalkboard with a wooden frame. The words "BE QUIET" are written on it in white chalk.	Gee-Yam-Beh
I'm Gonna Tell Your Dad	Goo-Dah-We Gow-We-We-Dum-Moo-Wak

Practice these words for 1-2
weeks before moving onto the
next lesson

Scan Here For Video #29:



Repeat After Me

Pronounce The Words With The Video Above

Stop	Nah-Gee
Take a bath	See- bee-Gus-Stee
I'm Cold	Nih-Gow-Wah-Ghin
Cry	Mah-Doh
Don't Cry	Guy Mah-Doh
Sing	Nig-Gah-Moh
Man	Nah-Bew

Practice these words for 1-2 weeks before moving onto the next lesson

Scan Here For Video #29:



Repeat After Me

Pronounce The Words With The Video Above

Woman	Iss-Gwew
Dog	Ah-Dim

Practice these words for 1-2 weeks before moving onto the next lesson

Scan Here For Video #30:



Repeat After Me

Pronounce The Words With The Video Above

Who	Ah-Wee-Nah
Why	Dan-Knee-Geh
Where	Don-Dee
When	Don-Spee
What	Gee-Gwhy
What	Gee-Gwhy-Yah

Practice these words for 1-2 weeks before moving onto the next lesson

Scan Here For Video #3!



Repeat After Me

Pronounce The Words With The Video Above

	See-Wee-Dah-Gun
	Biss-Skom-Nah
Pass the Pepper	Beeks-Sah-Nah Biss-Skom-Nah
Pass The Salt	Beeks-Sah-Nah See-Wee-Dah-Gun

Practice these words for 1-2
weeks before moving onto the
next lesson

Scan Here For Video #32:



Repeat After Me

Pronounce The Words With The Video Above

	Bin-Now-Wah-Soh
	Boon-Knee-Gohn
	Nig-Gah-Moh
	Guy-Yah
	Gee-Skwah
	Be-hoh
	Gim-Sah-Hoh

Practice these words for 1-2 weeks before moving onto the next lesson

Scan Here For Video #33:



Repeat After Me

Pronounce The Words With The Video Above

Remember	Giss-Gah-Seh
I Remember	Nihks-Gah-Sin
We Remember	Nihks-Skiss-Sah-Nahn

Practice these words for 1-2 weeks before moving onto the next lesson

Scan Here For Video #34:



Repeat After Me

Pronounce The Words With The Video Above

	Mih-Dass
	Big-Gwhy-Yahn
	Miss-Goot-Dah-Gay
	See-Beek-Squass-Sah-Gay
	Uss-Stoh-Din
	Doo-Doo-Sim-Me-Gahn
	Muss-Skiss-Seh-Nah

Practice these words for 1-2 weeks before moving onto the next lesson

Scan Here For Video #34:



Repeat After Me

Pronounce The Words With The Video Above

	Us-Ghiss-Suck
	Dub-Stah-Gun
	Iss-Gwuss-Sah-Gay
	Up-Be-Jew-Way-Ghass
	Buss-Stush-Sah-Gee
	Gee-Duss-Sah-Gee
	Buss-Stush-Giss-Sah-Knee
	Gee-Stush-Giss-Sah-Knee

Practice these words for 1-2 weeks before moving onto the next lesson

Scan Here For Video #35:



Repeat After Me

Pronounce The Words With The Video Above

	Munt-Doo-Gee-Sah-Gow
	Mee-You-Munt-Doo-Gee-Sah-Gun-Seh
	Ah-Wass-Suck
	Nih-Doo-Dah
	Nih-Doo-Dah-Mok
	Eye-Mee-Ghaa-Gee
	Ah-Gee-Ghaa-Gee



Practice these words for 1-2 weeks before moving onto the next lesson

Scan Here For Video #35:



Repeat After Me

Pronounce The Words With The Video Above

	Bweek-Gah-Doh
	Owe-We-Nah-Eee-Bweek-Gah- Doht

Practice these words for 1-2 weeks before moving onto the next lesson

Scan Here For Video #36:
Repeat After Me



Pronounce The Words With The Video Above

	Soon-Knee-Yow-Gah-Mik
	Gin-Nah-Mah-Soo-Gah-Mik
	Sous-Gah-Gay-Gew-Gah-Mik
	Muss-Gee-yew-Gah-Mik
	Ook-Gah-Mow-Uss-Gew-Gah-Mik
	Ah-Dow-yew-Gah-Mik
	Skin-Nah-Mah-Doo-Gah-Mik







Practice these words for 1-2
weeks before moving onto the
next lesson

Scan Here For Video #37:

Repeat After Me



Pronounce The Words With The Video Above

	Iss-Gwah-Deem
Come In	Bee-Dah-Gwee
	Ooo-Dee-Nah Iss-Gwah-Deem
	Ooo-Dee-Nah
Close it	Gip-Bah-Ha
Close the Door	Gip-Bah-Ha Iss-Gwah-Deem
	Bug-Gah-Me-Dah-Gay-Gee
	Mah-Dwee-Day-Gee
	Ah-Dwee-Yah-Wee

Practice these words for 1-2 weeks before moving onto the next lesson

Scan Here For Video #37:



Repeat After Me

Pronounce The Words With The Video Above

Go Out	Wee-Yah-Wee
	Ah-Beek-Wah-Hah
	Ah-Beek-Wah-Hah Iss-Gwah-Deem
<u>Yesterday</u>	Ooo-Dohk-See
TODAY	Ah-Nooch
Tomorrow	Wah-Bah-Geh







Practice these words
for 1-2 weeks before
moving onto the next
lesson

Scan Here For Video #38:



Repeat After Me

Pronounce The Words With The Video Above

	Wee-Bay-Gee
	See-Bee-Dah-Ging-Gee
	Gass-See-Dah-Gay-Gee
	See-Bee-Ah-Gah-Knee
	Gass-See-Ah-Gah-Knee
	Bah-Gway-Ah-Gah-Knee

Practice these words
for 1-2 weeks before
moving onto the next
lesson

Scan Here For Video #39:



Repeat After Me

Pronounce The Words With The Video Above

It's a beautiful day	Dah-Gahk-Geese-Sah-Gow
	See-Weep-Dah-moe
	Dee-Bwoss
	Giss-Stee-ew
What are you doing today?	Gee-Gwhy-You-See-Dye-Yin Ah-Nooch
	Doe-Bah-Gah-Sim-Moh-Dan
	Ghin-No-Way-Mah-Sue-Stum- Moh-In
	Ghin-No-Way-Mow-Wah-Suh

Practice these words for 1-2 weeks before moving onto the next lesson

Scan Here For Video #39:



Repeat After Me

Pronounce The Words With The Video Above



Bah-Mee-Gha-Gee



Mee-Skah-No

Practice these words
for 1-2 weeks before
moving onto the next
lesson

Scan Here For Video #40:



Repeat After Me

Pronounce The Words With The Video Above

Come With Me	Be-We-Ghee-Win
	Gih-Knee-Stoh-Sin
Can I Go With You?	Gah-Gee-We-Ghew-Din
	Nah-Mween-Skeet-Deen
Do You Know?	Gig-Skee-Deen
Don't Say That!	Gike-See-Dwee
	Niece-Stoh-Sin
Listen To Me	Nih-Doo-Doan

Practice these words for 1-2 weeks before
moving onto the next lesson

Scan Here For Video #40:



Repeat After Me

Pronounce The Words With The Video Above



	Nih-Do-Dah
	Gih-Knee-Stoh-Sin
How Are You Feeling?	Dan-Seh-Gih-Dah-Mach-Gha-Hon
	Nih-Dahk-Sin
Come Over Here.	Uss-Stum-Ooo-Dee

Practice these words
for 1-2 weeks before
moving onto the next
lesson

Scan Here For Video #41: Repeat After Me



Pronounce The Words With The Video Above

Make It	Ous-See-Dah
Fix It	Ous-See-Dah
Pay It	Dip-Bah-Ha
	Ah-Beh
	Mom-Doo-Knee-Dah
Come	Us-Stum
Bring	Bee-Dah
Sing	Nig-Gah-Moh

Practice these words for 1-2 weeks before
moving onto the next lesson

Scan Here For Video #41: Repeat After Me



Pronounce The Words With The Video Above

	Mun-Sah
Keep It	Gun-Nah-Wee-Dah
Keep Him/Her	Gun-Nah-Weem
Lead It	Knee-Gahn-Knee-Stah
	Knee-Gahn-Knee



Practice these words for 1-2
weeks before moving onto the
next lesson

Scan Here For Video #42:

Repeat After Me



Pronounce The Words With The Video Above

	See-Sow-Bay-Dan
	Mah-Sim-Bay-Aye
	Mah-Sim-Bay-Hin
Are you coming with them?	Eee-Wee-Bee-Wee-Ghee- Wah-Ghig
	Gike-Stoo-Dah
I Can't Do That	Mweek-Seh-Gah-Ghee-Do-Dean
	Nig-Gah-Ski-Dean
Don't Do That To Me	Gike-Seh-Do-Doan

Practice these words for 1-2 weeks before moving onto the next lesson

Scan Here For Video #43:

Repeat After Me



Pronounce The Words With The Video Above

	Nig-Gah-Moh
	Mah-Doh
	Guy-Mah-Doh
	Min-Knee-Gwee
	Me-Me-Doh
	Nih-Gow-Wah-Ghin
	Knee-Stoh-Sin
	Nuu-Dee-Gah-Dan



Practice these words for 1-2 weeks before
moving onto the next lesson

Scan Here For Video #43:

Repeat After Me



Pronounce The Words With The Video Above

	Nig-Gee-Spon
	See-Bee-Gah-Stee
Get Out Of here	Ah-Do-Way-Yah-We
Get Out Of here Now	Ah-Do-Way-Yah-We See-Mak

Practice these words
for 1-2 weeks before
moving onto the next
lesson

Scan Here For Video #44:



Repeat After Me

Pronounce The Words With The Video Above

Did you get paid?	Gih-Dip-Bah-Mah-Go-In-Chi
Are You Sick?	Yah-Goos-See-Eeen-Chi?
Where Did They Go?	Dan-Dee-Doo-Dee-Ghig
What Did You Say?	Dan-See-Dah-Ween?
Are You Tired?	Gah-Knee-Stoh-Sin
Where Are You Going?	Dan-Dee-Do-Deen
Where Are You Going?	Dan-Dee-We-Do-Dean
When?	Dan-Spee

Practice these words for 1-2 weeks before moving onto the next lesson

Scan Here For Video #44:



Repeat After Me

Pronounce The Words With The Video Above

When Are We Leaving?	Dan-Spee Eee-We-Sah-Bwee-Dean
Why?	Dan-Knee-Geh
Why Are You Crying?	Dan-Knee-Geh Gah-Mah-Doh-Ween
Do You Love Me?	Gih-Sah-Gee-Hin Chi
I Love You	Giss-Sah-Gee-Din

Practice these words
for 1-2 weeks before
moving onto the next
lesson

Scan Here For Video #45:

Repeat After Me



Pronounce The Words With The Video Above

I wonder Why?	Dan-Knee-Geet-Dah-Gwee
Do It Yourself	Doot-Dum-Mah-Suu
	Wee-Chaa-Hin
Help Out	Wee-Ghee-Dah-Soh
	Bee-Wee-Seep-Dum-Moh-Own
	See-Weep-Dah-Moe
Call Him/Her	Dee-Boss
Help Him/Her	Wee-Chii

Practice these words for 1-2 weeks before
moving onto the next lesson

Scan Here For Video #45:



Repeat After Me

Pronounce The Words With The Video Above

Bring It	Bee-Dah
Bring Him/Her	Bee-Suu

Practice these words
for 1-2 weeks before
moving onto the next
lesson

Scan Here For Video #46:

Repeat After Me



Pronounce The Words With The Video Above

Don't Do That	Gikes-Stoo-Dah
Don't Cry	Guy-Mah-Doh
Don't Fight	Guy-Nah-New-Ding-Gee
Don't Lie	Guy-Gah-Gee-Yah-Skeh
Don't Lie	Guy-Gee-Yah-Skeh
Don't Run	Guy-Bim-Bah-Dah
Don't Climb	Guy-Yah-Ah-Much-Cha-Wee
Don't Sleep	Guy-Ya-Nip-Bah

Practice these words for 1-2 weeks before
moving onto the next lesson

Scan Here For Video #46:



Repeat After Me

Pronounce The Words With The Video Above

Don't Yell Or Scream	Guy-Ya-Dah-Dee-Bwee
Don't Fool Around	Guy-Ya-Mah-Moo-Jew-Gah-Suu
Don't Fart	Guy-Bweek-Gah-Doh









Practice these words for
1-2 weeks before moving
onto the next lesson

Scan Here For Video #47:



Repeat After Me

Pronounce The Words With The Video Above

	Wah-Wah
	Wah-Gass
	Mee-Chim-Mah-Bwee
	Doo-Doo-Sah-Bwee
	Nup-Bah-Dahg
	Nup-Bah-Dah-Gwah
	Wee-Yass
	Bah-Gweese-Sah-Gun

Practice these words for 1-2 weeks before
moving onto the next lesson

Scan Here For Video #47:



Repeat After Me

Pronounce The Words With The Video Above

	See-Wee-Dah-Gun
	Biss-Skom-Nah
	Nip-Bee
	See-Ween-Gun

Practice these
words for 1-2 weeks
before moving onto
the next lesson

Scan Here For Video #48:



Repeat After Me

Pronounce The Words With The Video Above

Go For a Walk	See-Sow Ooo-Dee
Go For a Hair Cut	Do-Gee Skah-Mah
Go For a Mail	Doh-Dwah Snay-Gah-Knee
I'm Going to Court	Eee-Doh-Wee-Yah-Suu-Wee- Yahn
Go to Court	Doh-We-Uss-Sah-Wee

Practice these words for
1-2 weeks before moving
onto the next lesson

Scan Here For Video #49:



Repeat After Me

Pronounce The Words With The Video Above

	Nah-Stah
Go Put It Away	Doh-Nah-Stah
Come Put it Away	Be-Nah-Stah
Pick It Up	Moo-Sahk-Gin-Nah
Go Pick It Up	Doe-Moo-Sahk-Gin-Nah
Come Pick It Up	Be-Moo-Sahk-Gin-Nah
Throw It Away	Wee-Bin-Nah
Go Throw It Away	Doe-Wee-Bin-Nah

Practice these words for 1-2 weeks before
moving onto the next lesson

Scan Here For Video #49:



Repeat After Me

Pronounce The Words With The Video Above

Come Throw It Away	Bee-Wee-Bin-Nah
Quit Fooling Around	Boo-Moo-Chuug-Gass-Suu
Clean Up	Gin-Nah-Ghee-Cha-Gee
Go Clean Up	Doe-Gin-Nah-Ghee-Cha-Gee
Come Clean Up	Be-Gin-Nah-Ghee-Cha-Gee







Practice these words
for 1-2 weeks before
moving onto the next
lesson

Scan Here For Video #50:

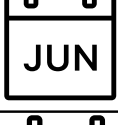

Repeat After Me

Pronounce The Words With The Video Above

 JAN	Gee-Sip-Bee-Sim
 FEB	Meek-Suu-Bee-Sim
 MAR	Niss-Skip-Bee-Sim
 APR	Aye-Gip-Bee-Sim
 MAY	Sahk-Beh-Gow-Bee-Sim
 JUN	Oh-Bask-Gah-Hew-Bee-Sim
 JUL	Oh-Bask-Goo-Bee-Sim
 AUG	Ooo-Bah-Who-Bee-Sim





Practice these words for 1-2 weeks before
moving onto the next lesson

Scan Here For Video #50:



Repeat After Me

Pronounce The Words With The Video Above

 SEP	Ooo-Noo-Jew-Doo-Bee-Sim
 OCT	Gass-Gaht-New-Bee-Sim
 NOV	Eeee-Goop-Bee-Sim
 DEC	Bah-Wah-Cha-Gahn-Nih-Sees

Practice these words for
1-2 weeks before moving
onto the next lesson

Scan Here For Video #51:



Repeat After Me

Pronounce The Words With The Video Above

	Bah-Way-Yah-Gay-Nahn
	Gass-See-Yah-Gah-Nance
	Bah-Goo-Goo-Hon
	Up-Skweess-Sah-Mon
	Ah-Nah-Skahn
	Ah-Gohp

Practice these words
for 1-2 weeks before
moving onto the next
lesson

Scan Here For Video #52:



Repeat After Me

Pronounce The Words With The Video Above

Leave It Alone	Boo-Knee-Gah
Don't Do That	Gikes-Do-Dah
Come	Ah-Stum
Come Here	Ah-Stum-Ooo-Dah
Move Over	Ah-Wass-Dee
Leave Him/Her Alone	Boo-Knee-Go
Come Closer	Bee-Ah-Stum-Dee
Come Closer	Us-See-Dee

Practice these words for 1-2 weeks before
moving onto the next lesson

We hope you enjoyed our 52 weeks of Cree book.

This has been a project full of love for our Cree language. Keep practicing these words and phrases again and again, until you can say them without my help or the help of this book.

If you want to learn from me even further, subscribe to our website www.repeataftermecree.com

There I will be hosting “Live” lessons each month.

If you want more, consider getting my USB stick with over 100 Cree Videos by scanning this QR code just below:



Thanks again for being a student of Repeat After Me Cree.

This is volume one. We are currently working on volume two of this program as you advance into longer phrases and conversational Cree.

Talk soon,

Julia Ouellete :)

